

SEQUENCE PUZZLE

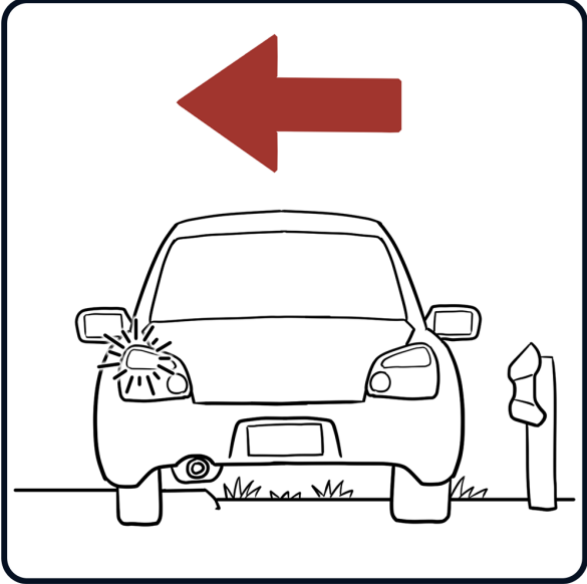

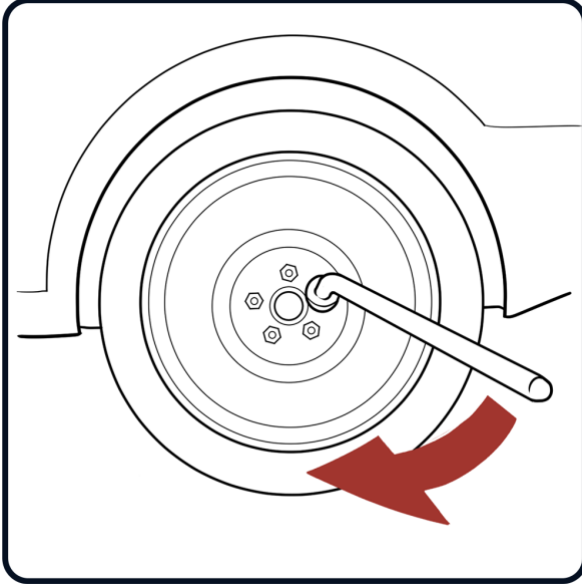
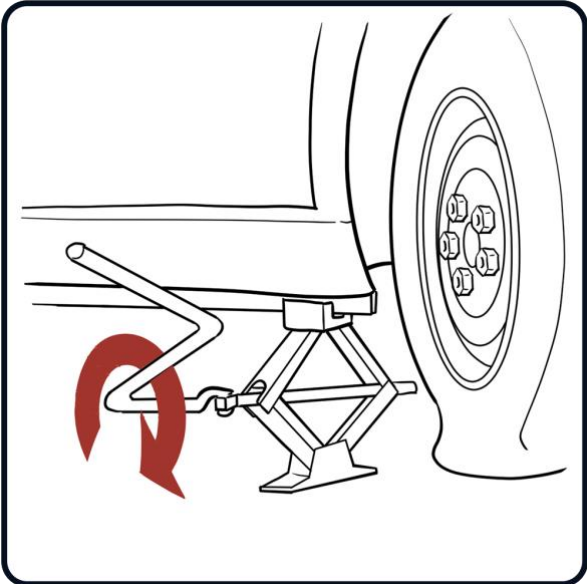
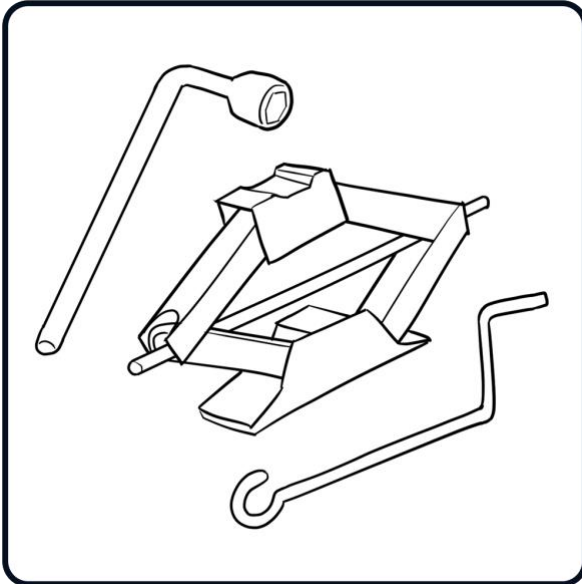
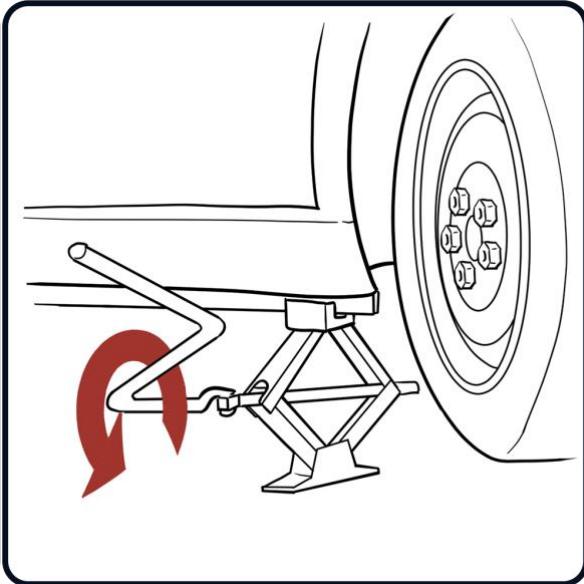
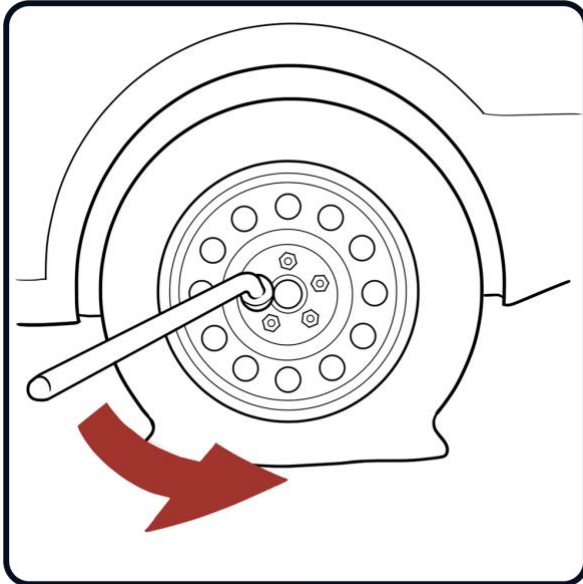
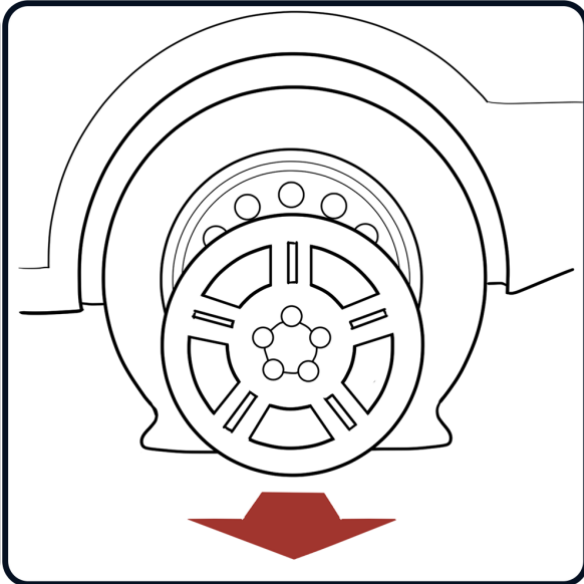
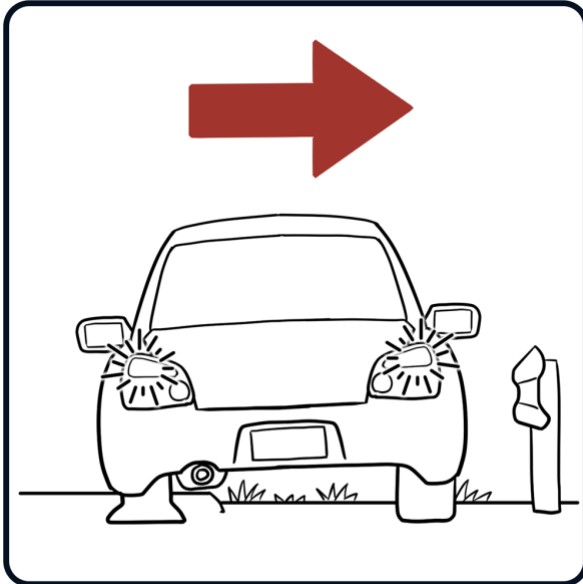

BACK IT UP

K20
L • E • A • R • N

